

# INSTRUCTION MANUAL

## EB-330DSC

Swivel Head-Dual Mitre Metal Cutting Band  
Saw with Conveyor System (415V)  
295 x 230mm (W x H) Rectangle



**B075**

<b>Table Of Contents</b>	<b>Page No</b>
<b>1 Safety Rules For All Tools .....</b>	<b>2</b>
<b>2 Specification .....</b>	<b>3</b>
<b>3 Features .....</b>	<b>4</b>
<b>4 Transportation &amp; Install .....</b>	<b>4</b>
<b>5 Make Proper Tooth Selection .....</b>	<b>6</b>
<b>6 BI-Metal Speeds And Feeds .....</b>	<b>6</b>
<b>7 Use Of Main Machine Parts .....</b>	<b>7</b>
<b>8 Maintaining .....</b>	<b>12</b>
<b>9 Cooling system .....</b>	<b>12</b>
<b>10 Trouble shooting .....</b>	<b>13</b>

**CAUTION**

**Install saw blade and blade guard**

before use. Set proper blade tension

to prevent any danger caused by

damaged saw blade or work piece.

**WARNING: FAILURE TO FOLLOW THESE RULES  
MAY RESULT IN SERIOUS PERSONAL INJURY**

As with all machinery there are certain hazards involved with operation and use of the machine. Using the machine with respect and caution will considerably lessen the possibility of personal injury. However, if normal safety precautions are overlooked or ignored, personal injury to the operator may result.

This machine was designed for certain applications only. We strongly recommend that this machine NOT be modified and/or used for any application other than for which it was designed. If you have any questions relative to its application DO NOT use the machine until you contact with us and we have advised you.

**Your machine might not come with a power socket or plug. Before using this machine, please do ask your local dealer to install the socket or plug on the power cable end.**

**1.SAFETY RULES FOR ALL TOOLS**

**A. USER:**

- (1). **WEAR PROPER APPAREL.** No loose clothing, gloves, rings, bracelets, or other jewelry to get caught in moving parts.  
Non-slip footwear is recommended. Wear protective hair covering to contain long hair.
- (2). **ALWAYS WEAR EYE PROTECTION.** Refer to ANSLZ87.1 standard for appropriate recommendations. Also use face or dust mask if cutting operation is dusty.
- (3). **DON'T OVERREACH.** Keep proper footing and balance at all times.
- (4). **NEVER STAND ON TOOL.** Serious injury could occur if the tool is tipped or if the cutting tool is accidentally contacted.
- (5). **NEVER LEAVE TOOL RUNNING UNATTENDED. TURN POWER OFF.** Don't leave tool until it comes to a complete stop.
- (6). **DRUGS, ALCOHOL, MEDICATION.** Do not operate tool while under the influence of drug, alcohol or any medication.
- (7). **MAKE SURE TOOL IS DISCONNECTED FROM POWER SUPPLY.** While motor is being mounted, connected or reconnected.
- (8). **ALWAYS** keep hands and fingers away from the blade.
- (9). **STOP** the machine before removing chips.
- (10). **SHUT- OFF** power and clean the BAND SAW and work area before leaving the machine.
- (11). **DO NOT** Touch the cutting Blade while the machine is term on.

**B. USE OF MACHINE:**

- (1). **REMOVE ADJUSTING KEYS AND WRENCHES.** Form habit of checking to see that keys and adjusting wrenches are removed from tool before turning it "on".
- (2). **DON'T FORCE TOOL.** It will do the job better and be safer at the rate for which it was designed.
- (3). **USE RIGHT TOOL.** Don't force tool or attachment to do a job for which it was not designed.
- (4). **SECURE WORK.** Use clamps or a vise to hold work when practical. It's safer than using your hand frees both hands to operate tool.
- (5). **MAINTAIN TOOLS IN TOP CONDITION.** Keep tools sharp and clean for best and safest performance. Follow instructions for lubricating and changing accessories.
- (6). **USE RECOMMENDED ACCESSORIES.** Consult the owner's manual for recommended accessories. The use of improper accessories may cause hazards.
- (7). **AVOID ACCIDENTAL STARTING.** Make sure switch is in "OFF" position before plugging in power cord.
- (8). **DIRECTION OF FEED.** Feed work into a blade or cutter against the direction of rotation of the blade or cutter only.
- (9). **ADJUST AND POSITION** the blade guide arm before starting the cut.
- (10). **KEEP BLADE GUIDE ARM TIGHT,** A loose blade guide arm will affect sawing accuracy.
- (11). **MAKE SURE** blade speed is set correctly for material being cut.
- (12). **CHECK** for proper blade size and type.
- (13). **STOP** the machine before putting material in the vise.
- (14). **ALWAYS** have stock firmly clamped in vise before starting cut.
- (15). **GROUND ALL TOOLS.** If tool is equipped with three-prong plug, it should be plugged into a three-hole electrical receptacle. If an adapter is used to accommodate atwo prong receptacle, the adapter lug must be attached to a known ground. Never removed the third prong.

**C. ADJUSTMENT :**

MAKE all adjustments with the power off. In order to obtain the machine. precision and correct ways of adjustment while assembling, the user should read the detailed instruction in this manual.

**D. WORKING ENVIRONMENT:**

- (1). **KEEP WORK AREA CLEAN.** Cluttered areas and benches invite accidents.
- (2). **DON'T USE IN DANGEROUS ENVIRONMENT.** Don't use power tools in damp or wet locations, or expose them to rain. Keep work area well lighted.
- (3). **KEEP CHILDREN AND VISITORS AWAY.** All children and visitors should be kept a safe distance from work area.
- (4). **DON'T** install & use this machine in explosive, dangerous environment.

**E. MAINTENANCE:**

- (1). **DISCONNECT** machine from power source when making repairs.
- (2). **CHECK DAMAGED PARTS.** Before further using of the tool, a guard or other part that is damaged should be carefully checked to ensure that it will operate properly and perform its intended function. Check for alignment of moving parts, binding of moving parts, breakage of parts, mounting, and any other conditions that may affect its operation. A guard or other part that is damaged should be properly repaired or replaced.
- (3). **DISCONNECT TOOLS** before servicing and when changing accessories such as blades, bits, cutters, etc.
- (4). **MAKE SURE** that blade tension and blade tacking are properly adjusted.
- (5). **RE-CHECK** blade tension after initial cut with a new blade.
- (6). **TO PROLONG BLADE LIFE ALWAYS** release blade tension at the end of each workday.
- (7). **CHECK COOLANT DAILY** Low coolant level can cause foaming and high blade temperatures. Dirty coolant can clog pump, cause crooked. Rust, low cutting rate and permanent blade failure. Dirty coolant can cause the growth of bacteria with ensuing skin irritation.
- (8). **WHEN CUTTING MAGNESIUM NEVER** use soluble oils or emulsions (oil-water mix) as water will greatly intensify any accidental magnesium chip fire. See your industrial coolant supplier for specific coolant recommendations when cutting magnesium.
- (9). **TO PREVENT** corrosion of machined surfaces when a soluble one is used as coolant, pay particular attention to wiping dry the surfaces where fluid accumulates and does not evaporate quickly, such as between the machine bed and vise.

**F. SPECIFIED USAGE:**

This machine is used only for general metals cutting within the range of cutting capacity.

**G. NOISE:**

A weighted sound pressure level : under 80 dB.

**H. SAFETY DEVICE:**

Interlock switch on cutting area as soon as the cover of cutting area is open, machine will stop at once with the function of this switch. Do not remove this switch from machine for any reason, and check its function frequently.

## 2.SPECIFICATION

MOTOR		1.65HP	415V/50HZ
Saw Blade Speed		MPM	37~74(50Hz)
Blade Size (mm)		27x0.9x2965mm	
Dimension LxWxH (mm)		1350X715X1326mm	
Packing	N.W / G.W (kgs)	295/ 325	
	Measurement	1550x800x1480mm	
Cutting Capacity	0°	○(mm)	240
		□(mm)	240
	+ 45°	○(mm)	200
		□(mm)	200
	+60°	○(mm)	125
		□(mm)	125
	+ 45°	○(mm)	160
		□(mm)	150

## 3.FEARTURES:

1. This machine is useful for cutting normal steel, steel pipe, and provides cutting angle at + 60° and +45° by the swivel head.
2. A tooth selection chart was provided on the machine for cutting reference.
3. Variable speed control gives convenient selection of speeds. (This machine comes with a standard 2-speed motor. But can be purchased with a DC driven motor as an option.)
4. This machine is using manual cutting by pulling down the saw bow by hand. Start(press) button is located at the handle of the saw bow. Motor stops when button was released.
5. Stability of the machine, plus working table height is 950 mm, conforming to human engineering.
6. The one-inch blade and carbide guide provide better result of the cutting surface and efficiency.
7. The one-piece casting and one time CNC processing provide better rigidity and precision of the machine.
8. The one-piece and full coverage blade cover conforms to CE stipulation. Well coolant fluid collection system provides clean and dry, and safety of the working area.
9. Chip pan underneath the working table prevents coolant fluid leaking and keep floor dry.
10. Coolant for cutting,, water : oil = 40 : 1 oil specification.

## 4.TRANSPORTATION & INSTALLATION:

### 4-1.Unpacking

1. Transportation to desired location before unpacking, please use-lifting jack. (Fig. B)
2. Transportation after unpacking, please use heavy duty fiber belt to lift up the machine.

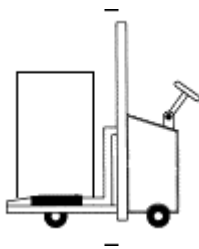

Fig, B

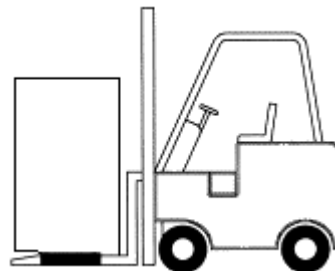

**ALLWAYS KEEP PROPER FOOTING & BALANCE WHILE MOVING THIS MACHINE.**

**4-2. TRANSPORTATION OF MACHINE:**

As this machine weights 404kgs(890.7lbs) it is recommended that the machine be transported with help of lifting jack.

**Transportation Recommendation:**

1. **Tighten** all locks before operation.
2. **Always** keep proper footing & balance while moving this machine, and only use a heavy duty of fiber belt to lift the machine as per Fig. A.
3. **TURN OFF** the power before wiring & be sure machine is properly grounded. Overload & circuit breaker are recommended for safety wiring.
4. **Tighten** 4 bolts to base holes after machine is balanced.
5. **Check** carefully if the saw blade is running in counter-clockwise direction if not, reverse the wiring per circuit diagram, then repeat the running test.
6. **Keep** machine always out from sun, dust, wet, or raining area.

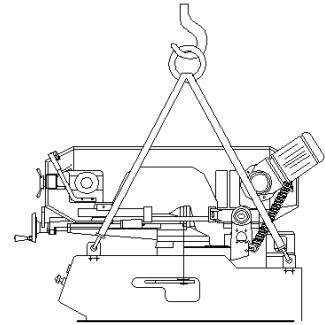

**Fig. A**

**4-3. Installation:**

- (1) **Always** Keep proper footing & balance while moving this 404kgs machine. Hang the machine up, away from the floor, take away the 4 pads and assemble them on the auxiliary stand. Fix the machine on the auxiliary stand and lock the connection nut.
- (2) **Finish** removing this wooden case/crate from the machine. Unbolt the machine from the crate bottom.
- (3) **Position** & tighten 4 bolts into base holes properly after machine in balance.
- (4) **Turn off** the power before wiring & be sure machine is in proper grounding. Overload & circuit breaker is recommended for safety wiring.
- (5) **Keep** machine always out from sun, dust, wet, raining area.

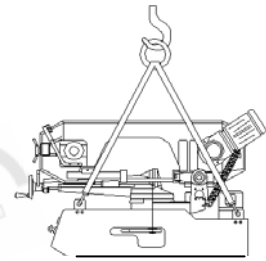

**Fig. B**

**5-4. CLEANING & LUBRICATING**

- (1) Your machine has been coated with a heavy grease to protect it in shipping. This coating should be completely removed before operating the machine. Commercial degreaser, kerosene or similar solvent may be used to remove the grease from the machine, but avoid getting solvent on belts or other rubber parts.
- (2) After cleaning, coat all bright work with a light lubricant. Lubricate all points . with a medium consistency machine oil.

**5. MAKE PROPER TOOTH SELECTION**

For maximum cutting efficiency and lowest cost per cut, it is important to select the blade with the right number of teeth per inch (TPI) for the material being cut. The material size and shape dictate tooth selection.

**TOOTH SELECTION**

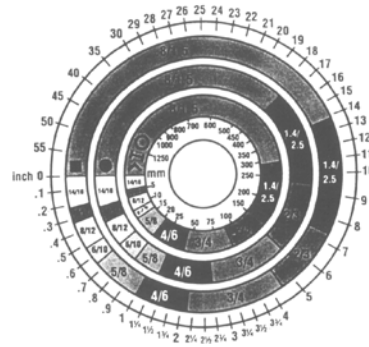

You need to consider:

**The width of the cut** - That is, the distance in the cut that each tooth must travel from the point it enters the work-piece until it leaves the work-piece, and

1. The shape of the work-piece.

- **Squares, Rectangles, Flats (Symbol : ■)**  
Locate the width of cut on the chart. (Inches on the outer circle and millimeters on the inner circle.) Select the tooth pitch on the ring marked with the square shape which aligns with the width of cut.  
EXAMPLE: 6" (150mm) square, use a 2/3 Vari-Tooth.
- **Round Solids (Symbol : ●)**  
Locate the diameter of your work-piece on the chart. Select the tooth pitch on the ring marked with the round shape which aligns with the size of stock you are cutting.  
EXAMPLE: 4" (100mm) round, use a 3/4 Vari-Tooth.
- **Tubing, Pipe, Structural ( Symbol : O H ^ )**  
Determine the average width of cut by dividing the area of the work-piece by the distance the saw blade must travel to finish the cut. Locate the average width of cut on the chart. Select the tooth Ditch on the ring marked with the tubing and structural shape, which aligns with the average width you are cutting.

EXAMPLE: 4"(100mm) outside diameter, 3"(75mm) inside diameter tubing.

$$\begin{aligned} 4''(100\text{mm}) \text{ OD} &= 12.5 \text{ sq.in. } (79\text{cm}^2) \\ 3''(75 \text{ mm}) \text{ ID} &= 7.0 \text{ sq.in. } (44\text{cm}^2) \end{aligned}$$

---

$$\text{Area} = 5.5 \text{ sq.in. } (35\text{cm}^2)$$

$$\begin{aligned} &5.5 \text{ sq.in. } (35\text{cm}^2) / 4'' (100\text{mm}) \\ &\text{distance} = 1.38(35\text{mm}) \text{ average width} \\ &1.38'' (35\text{mm}), \text{ use a } 4/6 \text{ Vari-Tooth} \end{aligned}$$

**NOTE:** The band speed and cutting rate recommendations presented on this chart are approximations and are to be used as a starting point for most applications. For exact sawing parameters' consult your saw blade supplier.

**6. BI-METAL SPEEDS AND FEEDS**

These figures are a guide to cutting 4"(100mm) material (with a 314 Vari-Tooth) when using a cutting fluid.

- Increase Band Speed:
- 15% When cutting 1/4"(6.4mm) material (10/14 Vari-Tooth)
  - 12% When cutting 3/4"(19 mm) material (6/10 Vari-Tooth)
  - 10% When cutting 1-1/4"(32 mm) material(5/8 Vari-Tooth)
  - 5% When cutting 2-1/2" (64 mm) material(4/6 Vari-Tooth)
- Decrease Band Speed: 12% When cutting 8"(200mm) material(2/3 Vari-Tooth)

MATERIAL	ALLOY ASTM NO.	BAND SPEED	
		FT./MIN	M/MIN
Copper Alloy	173,932	314	96
	330,365	284	87
	623,624	264	81
	230,260,272	244	74
	280,264,632,655	244	74
	101,102,110,122,172	234	71
	1751,182,220,510	234	71
	625,706,715,934	234	71
	630	229	70
Carbon Steel	811	214	65
	1117	339	103
	1137	289	88
	1141,1144	279	85
	1141 HI STRESS	279	85
Carbon Steel	1030	329	100
	1008,1015,1020,1025	319	97
	1035	309	94
	1018,1021,1022	299	91

	1026,1513	299	91
	A36(SHAPES),1040	269	82
	1042,1541	249	76
	1044,1045	219	67
	1060	199	61
	1095	184	56
Ni-Cr-Mo Alloy Steel	8615,8620,8622	239	73
	4340,E4340,8630	219	67
	8640	199	61
	E9310	174	53
Tool Steel	A-6	199	61
	A-2	179	55
	A-10	159	49
	D-2	90	27

	H-11,H-12,H-13	189	58
Stainless Steel	420	189	58
	430	149	46
	410,502	140	43
	414	115	35
	431	95	29
	440C	80	24
	304,324	120	36
	304L	115	35
	347	110	33
	316,316L	100	30
	416	189	58

**TELLTALE CHIPS**

Chips are the best indicators of correct feed force. Monitor chip information and adjust feed accordingly.

Thin or powdered chips – increase feed rate or reduce band speed.

Burned heavy chips – reduce feed rate and/or band speed.

Curly silvery and warm chips – optimum feed rate and band speed.

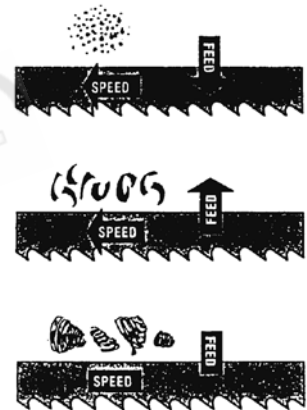

**7.USE OF MAIN MACHINE PARTS**

**7-1.POWER SYSTEMS AND CONTROL PANEL**

The electrical rating of your band saw is with 400 volt-3 phase, magnetic control.  
 Before connecting your machine to an electrical power system, be sure the motor shaft is running in the correct direction.  
 Refer to the electrical wiring diagram supplied with your machine for instructions on how to connect saw to power source. Power must be cut off when wheel cover is opened or during repairing.  
 Please check the moving direction of the blade. If the blade is moving in the wrong direction, please re-connect the wire.

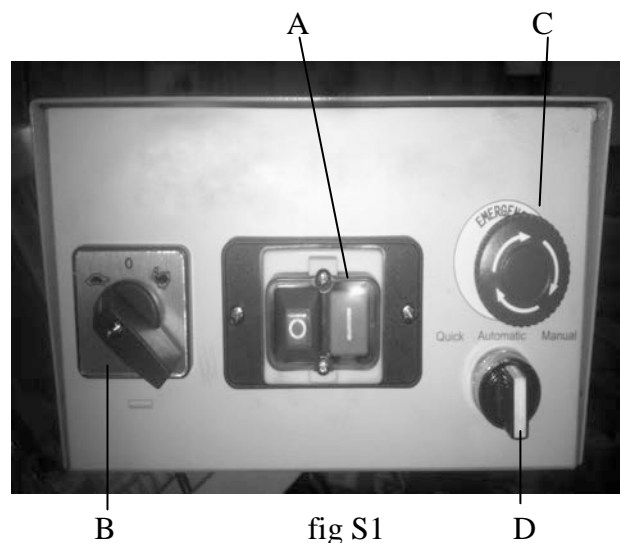

fig S1



Operation way :

1. Push the green button(A)(fig.S1) to connect the power for the machine .
2. **Fast moving saw-farm to approach cutting material**  
Turn the switch (D(fig.S1)) to “Quick” ,push the handle of limit switch(A)(fig.S2),it can move the saw farm manually to near the material.
3. **Auto Cutting**  
Turn the switch (D) (fig.S1) to “Automatic” , push the handle of limit switch(A)(fig.S2) ,  
The machine will going down and cut by itself.  
Adjust (A) (fig.S3) to set up the down-feed speed in saw-farm
4. **Manual Cutting**  
Turn the switch (D) (fig.S1) to “Manual “ , push the handle of limit switch(A)(fig.S2),  
The machine will convert into the manual cutting .  
Adjust the spring and (A) (fig.S3) to use manual operation
5. **Select the blade cutting speed** (B) (fig.S1)
6. **Emergency Stop switch** (C) (fig.S1)



A fig S2



A fig S3

#### 7-2.ADJUSTING UPWARD AND DOWNWARD TRAVEL OF SAW ARM

The downward travel of the saw arm should be adjusted so that when the saw arm is in the extreme downward position, the teeth of the blade will not touch the table surface. The stop screw (G) (fig.S4) is used to adjust the distance between blade and table surface. After the distance is adjusted, tighten lock nut.  
The screw (F) (fig.S4) is used to adjust the saw arm upward angle, tighten lock nut.

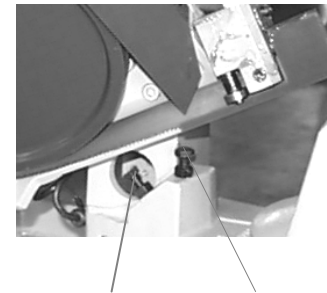

F figS4 G

#### 7-2. End-cutting adjustment

Loosen the screw (F) (fig.S5) , adjust the switch touch plate (F) (fig.S5) up or down .

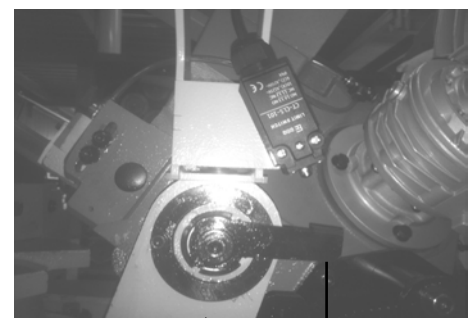

A figS5 B

**7-3.ADJUSTING BLADE TENSION AND BLADE TRACKING**

To tension the blade, turn the blade tension handle (fig. 1)(A) clockwise. To set up at the middle of green position .

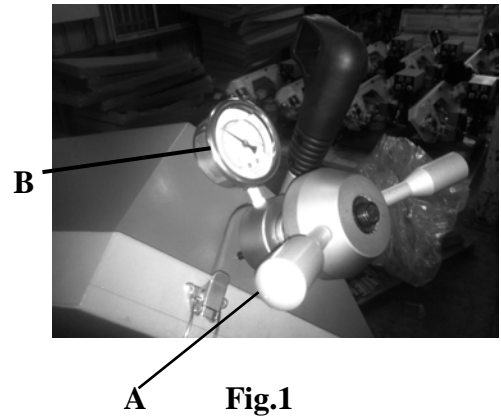

**Fig.1**

**7-4.ADJUSTING CUTTING WIDTH**

First loosen screw (A) (fig.2). Move the left blade guide bar to the suitable position. Then tighten screw (A).

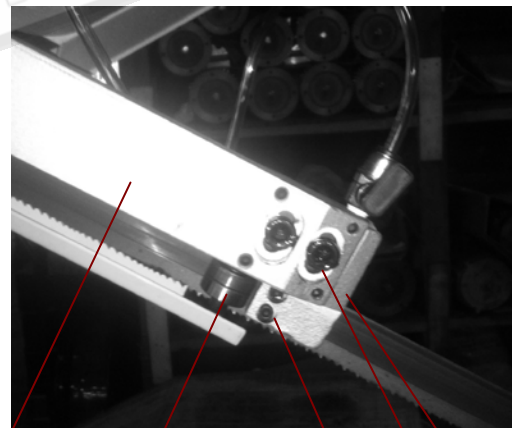

**Fig. 2**

**7-5.ADJUSTING BLADE GUIDE ROLLER BEARINGS, CARBIDE BLADE GUIDES AND BACK-UP BEARINGS AND CLEARING THE CUTTING CHIP**

Before making the following adjustments, make sure the blade is tracking and tensioned properly:

- 1.The back of the blade (A) (fig3) should ride against the back-up block (B) (fig3-1). To adjust, loosen set screw (C) and move the guide block (D) up or down, until it lightly touches the back of the blade .
- 2.The saw blade (A) should also ride between and lightly touch the two blade guide roller bearings (E) (fig. 3)
- 3.The carbide blade guides (H) (fig 3-1) should also be adjusted so they lightly touch the blade by loosening screw (K). and adjust the screw (F) (fig 3-1) to have right space for blade
4. The blade guide roller bearings, carbide guides and backup bearing on holder (fig 9 ) should be adjusted in the same manner.
5. Cutting chips on the blade will be cleared by the steel brush.



**Fig.3**

**A E F K C D**

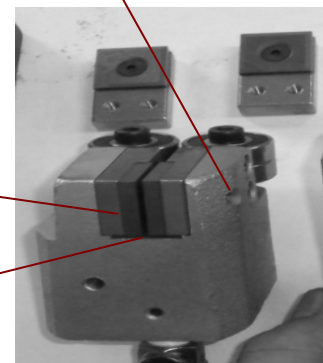

**Fig.3-1**

**7-6.OPERATING THE TRU-LOCK VISE SYSTEM INSTRUCTIONS**

To operate, proceed as follows:

- 1) Raise the arm 2” above the work piece; Put your work piece on the table. Move the vise handle (A) (fig. 6) upwards to an angle of 45 degree (a-Half opened) to loosen the vise. Move the vise jaw bracket against the work piece by turning the rectangular handle (B) (fig. 6) for . Push down on the vise handle (A) to lock the work piece in position.

To loosen the work piece from the vise, hold the work piece and lift the vise handle (A) (fig. 6) to a 90 degree position (completely opened). Remove work piece.

- 3) **To fast moving the vise** , to push the handle of (A) (fig. 5). Then push/pull (B) (fig. 6)



**Fig.5**

**CONTINUED CUTTING:**

When you need to cut a work piece many times, just raise the vise handle (A) to loosen and adjust work piece position. Then push down on the same handle to tighten. You can also push the vise handle (A) down first, and then tightening the vise by turning the rectangular handle (B) clockwise. After finishing the cut, you can loosen the work piece by turning rectangular handle only. This True-Lock Vise System has a 4mm tightening travel when the rectangular handle is completely opened. There is only a 2mm tightening travel necessary for normal metal materials. The operator can tighten the work piece by pushing down the vise handle (A) with a certain amount of pressure depending on hardness of work piece.

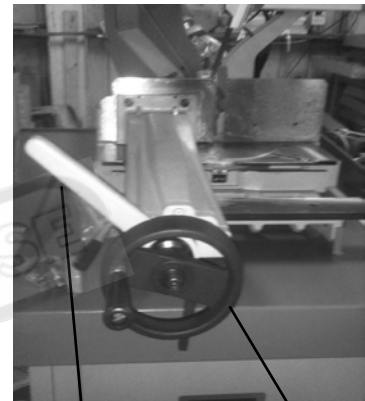

**A Fig 6**

**B**

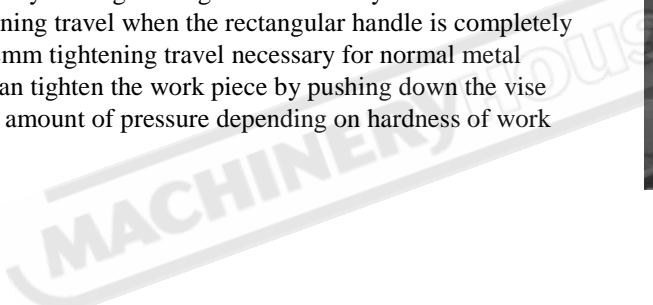

**A Fig 7**

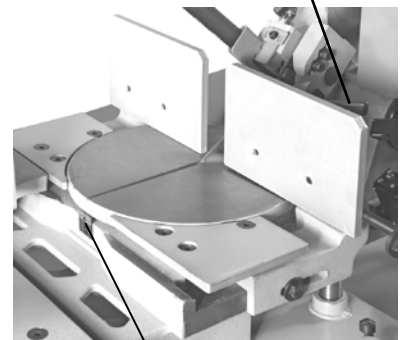

**B**

**7-7.VARIABLE CUTTING ANGLE SELECTION**

Please proceed as follows to obtain desired cutting angle.

The swivel range is from 0° to 60° clockwise.

Before swinging the base, make sure there is nothing in the way, or any interference.

- 1. Unscrew out the knob (A) (fig. 7) swing the saw arm . Refer to scale on (B) (fig. 7) for degree.
- 2. Screw out the knob (A) (fig. 7), then start the cutting.

### 7-8.vise for left and right position

Please proceed as follows to obtain desired clamp vise moving to left and right .

Before moving the vise, make sure there is nothing in the way, or any interference.

1. Unscrew out the knob (A) (fig.7-1) and push the vise
2. The handle will be left side when the vise stay in left side as(fig.7-2 )
3. And push the handle by anti-clockwise until hear the noise from the vise push the handle  
Then the handle will be left side (fig.7-3 )



**A Fig 7-1**

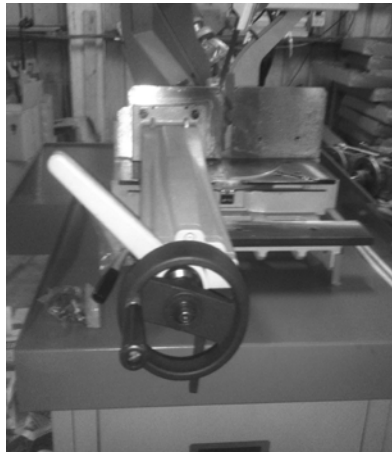

**Fig 7-2**

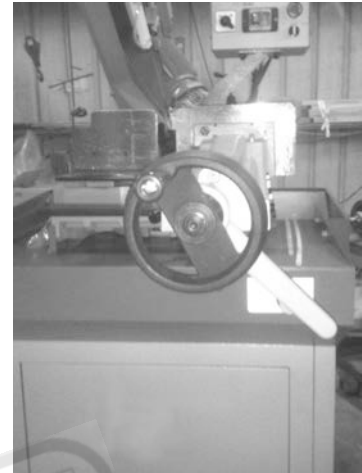
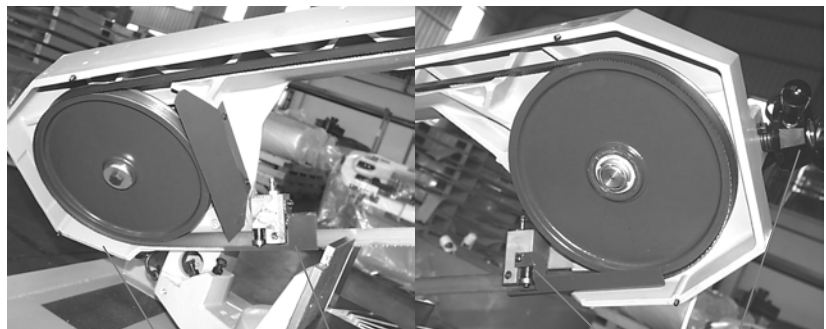

**Fig 7-3**

### 7-9.REMOVING AND INSTALLING THE BLADE

When it is necessary to replace the blade, proceed as follows:

1. Raise the saw frame about 6" and close the feed on/off knob by turning it clockwise as far as it will go (fig 8).
2. Move the blade guide arm to the right.(Fig.9).
3. Disconnect the machine from the power source. Loosen cover screw, remove cover (A), open the cover (B), remove cover (C) , then clean the chips and dirt inside the machine.
4. Release blade tension (F) (fig 9) by turning the blade tension hand-wheel counterclockwise.



**Fig.8 A**

**B**

**Fig.9 C**

**F**

5. Remove the blade from both wheels and out of each blade guide. But remove side (B) saw blade. When totally released, then remove the side (A).
6. Make sure the teeth of the new blade are pointing in the right direction. IF necessary, turn the blade inside out.
7. Place the new blade on the wheels. In the blade guides and adjust blade tension and blade guides.

## 8.MAINTAINING

That's easier to keep machine in good condition or best performance by means of maintaining it at any time than remedy it after it is out of order.

### (1) Daily Maintenance (by operator)

- (a) Fill the lubricant before starting machine everyday.
- (b) If the temperature of spindle caused over-heating or strange noise, stop machine immediately to check it for keeping accurate performance.
- (c) Keep work area clean; release vise, cutter, work-piece from table; switch off power source; take chip or dust away from machine and follow instructions lubrication or coating rust proof oil before leaving.

### (2) Weekly Maintenance

- (a) Clean and coat the cross leading screw with oil.
- (b) Check to see if sliding surface and turning parts lack of lubricant. If tile lubricant is insufficient, fill it.

### (3) Monthly Maintenance

- (a) Check if the fixed portion has been loose.
- (b) Lubricate bearing worm, and worm shaft to avoid the wearing.

### (4) Yearly Maintenance

- (a) Adjust table to horizontal position for maintenance of accuracy.
- (b) Check electric cord, plugs, switch, at least once and a year to avoid loosening or wearing.

## 9.Cooling system

This machine service cooling system .

The tube was separate. You need to connect it .

1. Assemble the machine stand
2. Assemble the chip-tank (A) ( Fig 10 )
3. Put the water tank (A) ( Fig 10-1 ) into the machine stand
4. Connect the tube( B) ( Fig 10-1 ) from the chip-tank (A) ( Fig 10 ) to the water tank
5. Screw tight of the tube at the down part of chip tank by the screw( B) ( Fig 10-2 )



A Fig.10-1 B

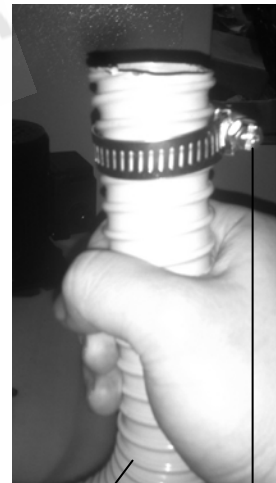

A Fig.10-2 B

### 9-1 .Chips clean

That is easier to clean the chips by moving the chips tank A ( Fig 10 )

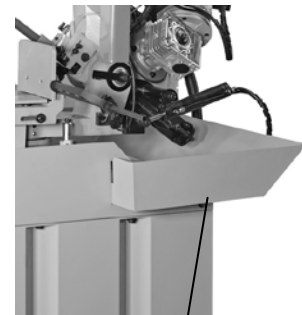

Fig.10 A

## 10. TROUBLE SHOOTING

Symptom	Possible Cause(s)	Corrective Action
Machine can not be started	<ol style="list-style-type: none"> <li>1. Power is not plugged; the power light on control panel is not on.</li> <li>2. Motor cannot be started; power was cut by limit switch.</li> <li>3. Operation button cannot be normally operated.</li> </ol>	<ol style="list-style-type: none"> <li>1. Check the motor specification; connect the power with correct power supply. Make sure the power light is on.</li> <li>2. Make sure the cover is in correct position.</li> <li>3. Push the emergency button; return it to original position. Then release the emergency button.</li> </ol>
Excessive Blade Breakage	<ol style="list-style-type: none"> <li>1. Materials loosen in vise.</li> <li>2. Incorrect speed or feed</li> <li>3. Blade teeth spacing too large</li> <li>4. Material too coarse</li> <li>5. Incorrect blade tension</li> <li>6. Teeth in contact with material before saw is started</li> <li>7. Blade rubs on wheel flange</li> <li>8. Miss-aligned guide bearings</li> <li>9. Blade too thick</li> <li>10. Cracking at weld</li> </ol>	<ol style="list-style-type: none"> <li>1. Clamp work securely</li> <li>2. Adjust speed or feed</li> <li>3. Replace with a small teeth spacing blade</li> <li>4. Use a blade of slow speed and small teeth spacing</li> <li>5. Adjust to where blade just does not slip on wheel</li> <li>6. Place blade in contact with work after motor is started</li> <li>7. Adjust wheel alignment</li> <li>8. Adjust guide bearings</li> <li>9. Use thinner blade</li> <li>10. Weld again, beware the welding skill.</li> </ol>
Premature Blade Dulling	<ol style="list-style-type: none"> <li>1. Teeth too coarse</li> <li>2. Too much speed</li> <li>3. Inadequate feed pressure</li> <li>4. Hard spots or scale on material</li> <li>5. Work hardening of material.</li> <li>6. Blade twist</li> <li>7. Insufficient blade</li> <li>8. Blade slide</li> </ol>	<ol style="list-style-type: none"> <li>1. Use finer teeth</li> <li>2. Decrease speed</li> <li>3. Decrease spring tension on side of saw</li> <li>4. Reduce speed, increase feed pressure</li> <li>5. Increase feed pressure by reducing spring tension</li> <li>6. Replace with a new blade, and adjust blade tension</li> <li>7. Tighten blade tension adjustable knob</li> <li>8. Tighten blade tension</li> </ol>
Unusual Wear on Side/Back of Blade	<ol style="list-style-type: none"> <li>1. Blade guides worn.</li> <li>2. Blade guide bearings not adjust properly</li> <li>3. Blade guide bearing bracket is loose</li> </ol>	<ol style="list-style-type: none"> <li>1. Replace.</li> <li>2. Adjust as per operators manual</li> <li>3. Tighten.</li> </ol>
Teeth Ripping from Blade.	<ol style="list-style-type: none"> <li>1. Tooth too coarse for work</li> <li>2. Too heavy pressure; too slow speed.</li> <li>3. Vibrating work-piece.</li> <li>4. Gullets loading</li> </ol>	<ol style="list-style-type: none"> <li>1. Use finer tooth blade.</li> <li>2. Decrease pressure, increase speed</li> <li>3. Clamp work piece securely</li> <li>4. Use coarser tooth blade or brush to remove chips.</li> </ol>
Motor running too hot	<ol style="list-style-type: none"> <li>1. Blade tension too high.</li> <li>2. Drive belt tension too high.</li> <li>3. Blade is too coarse for work</li> <li>4. Blade is too fine for work</li> <li>5. Gears aligned improperly</li> <li>6. Gears need lubrication</li> </ol>	<ol style="list-style-type: none"> <li>1. Reduce tension on blade.</li> <li>2. Reduce tension on drive belt.</li> <li>3. Use finer blade.</li> <li>4. Use coarse blade.</li> <li>5. Adjust gears so that worm is in center of gear.</li> <li>6. Check oil path.</li> </ol>

	7. Cut is binding blade	7. Decrease reed anti speed
Bad Cuts (Crooked)	<ol style="list-style-type: none"> <li>1. Feed pressure too great.</li> <li>2. Guide bearings not adjusted properly</li> <li>3. Inadequate blade tension.</li> <li>4. Dull blade.</li> <li>5. Speed incorrect.</li> <li>6. Blade guides spaced out too much</li> <li>7. Blade guide assembly loose</li> <li>8. Blade truck too far away from wheel flanges</li> </ol>	<ol style="list-style-type: none"> <li>1. Reduce pressure by increasing spring tension on side of saw</li> <li>2. Adjust guide bearing, the clearance cannot greater than 0.001.</li> <li>3. Increase blade tension by adjust blade tension</li> <li>4. Replace blade</li> <li>5. Adjust speed</li> <li>6. Adjust guide space.</li> <li>7. Tighten</li> <li>8. Re-track blade according to operating instructions.</li> </ol>
Bad Cuts (Rough)	<ol style="list-style-type: none"> <li>1. Too much speed or feed</li> <li>2. Blade is too coarse</li> <li>3. Blade tension loose</li> </ol>	<ol style="list-style-type: none"> <li>1. Decrease speed or feed.</li> <li>2. Replace with finer blade.</li> <li>3. Adjust blade tension.</li> </ol>
Blade is twisting	<ol style="list-style-type: none"> <li>1. Cut is binding blade.</li> <li>2. Too much blade tension</li> </ol>	<ol style="list-style-type: none"> <li>1. Decrease reed pressure.</li> <li>2. Decrease blade tension.</li> </ol>
Saw arm can not Be raised up after Pushing the raising Button	<ol style="list-style-type: none"> <li>1. Improper setting of depth gauge</li> </ol>	<ol style="list-style-type: none"> <li>1. Press the emergency stop Button and RESET.</li> <li>2. Check the upper limit switch and stop round Position. Make sure the limit switch is always underneath the stop round bar.</li> <li>3. Check the oil gauge; make sure the oil is in proper range.</li> <li>4. Check the motor revolution direction; make sure the motor revolution is in clock-wise direction.</li> </ol>

PARTS LIST				P1/5
MODEL NO. EB330DSC				
NO	DESCRIPTION	BOM	SPEC	QTY
1	CAP Screw	XCCMWS1025	M10x25	1
2	Washer	27002	40x40.2x5	2
3	Shaft	27003		1
4	Anchor Block	27004		1
5	C- ring		C扣25	1
5*1	CAP Screw	XCCMWS61035	CAP M10x35	4
5*2	CAP Screw	XCCMWS1025	CAP M10x25	5
6	Bearing	QX6205	6205	2
7	Left Body frame	28507		1
7-1	PIPE connect	21007G*1		1
7-2	PIPE connect for Body frame	30007*2	50x100x730	1
7-3	Right Body frame	30007*3		1
10	Knob	27010		2
11	Blade Tension Handle	27011		1
12	Big Waswher	QX51203	51203	1
13	Lead Screw	27013*3	16*240mm	1
13-1	tention gauge	UX1V		1
13-2	Washer	XCWMWQC16311		1
14	Hex. Socket Head Screw	XCCMWS6825	M8X25L	6
15	Fixed Block	27015		2
16	CAPSCREW	XCCMWS6840	M8x40	4
17	Bushing	27031B	20x25 内:12 自働	1
18	Reducer Block	30018		1
19	Washer	Spring washer M8	M8	4
20	Screw	XCM6F825	M8x25	4
20*1	nut	XCM6A8	M8	4
21	Reducer	30021		1
22	Motor	27022/ZU005/ZE011		1
25	CAP Screw	XCCMFS61025	M10x25	1
27	Key	2J037	8x7x70	1
28	Output Shaft	30028		1
29	Key	2J021	7x7x30	1
30	Bearing	27030	6906	2
31	Spring Support	30031		1
31*1	spring holder screw	27031A*1		1
32	Spring	32147		1
33	Steel Brush	30033,27033*2,*3,*4(1)-(3)		1
33*1	Blade Cover	30033*1		1
33*2	Brush holder	30033*2		1
34	Screw		M16x40	1
34*1	Bearing Cover	75081		1
35	Spring Washer	32042(1)		2
36	Frame Pivot Shaft	30036		1
38	Screw			2
39	Screw		8*25	1
39-1	copper	12060C		1
40	Fixed Block	32091		1



PARTS LIST		MODEL NO. EB330DSC		
		P2/5		
NO	DESCRIPTION	BOM	SPEC	QTY
41	Set Screw	XCCMJS688	M8x8	2
42	Switch	51021	VMN-15S	1
43	Handel	27043		1
44	Handel Pipe	285044		1
45	Screw		M6x20	1
47	Screw	XCM6F835	M8x35	2
48	Blade adjust stick	30048		1
50	Screw	XCMJ510	M5x10	2
52	Blade Cover (Front)	27052 #7037		1
53	Blade Adjust (Front)	30053		1
54	Guide	32084		2
55	Guide holder	32078		4
55-1	Guide	32079		4
56	Screw			4
60	Eccentric Guide	27057		4
61	Bearing	QX608(1)	608	8
62	Screw	XCM6F515	5x15	4
63	CAPSCREW	XCCMWS6840	M8x40	8
64	Spring Washer	XCWMWCC8	M8	1
65	Blade Adjustable (Rear)	30065		1
65-1	Valve	21049G*1		2
66	CAPSCREW			1
67	Chip Plate	30067#7037		1
68	Screw			2
69	Spring Washer	XCWMWCC5		1
70	Screw	XCM6F510	M5	1
71	Drive Wheel	30071		1
72	Washer	27002	40x10.2x5	1
73	Screw	XCCM1S61025		1
74	CAPSCREW			1
74-1	Washer			2
74-2	Nut			2
74-3	Cover Switch			1
75	Blade Back Cover	30075 #7035		1
75-1	Blade Left Cover	30075*1#7037		1
75-2	Blade up cover	30075*2#7037		1
75-3	Blade down cover	30075*3#7035		1
76	Wire fixed Board	30076		1
76-1	CAPSCREW	XCCMWS6816		2
78	Saw Blade	30078	2965x27x0.9	1
79	Idler Wheel	30079		1
80	C-ring	XCWMDCS25	S-25	1
81	Screw	XCM6F820	M8x20	1
82	Washer	XCM8233	M8 X23X3	1
83	Wheel	15075		1
84	Bearing Cover	27085		1
84*1	Bearing 51106	27086	51106	1

PARTS LIST		MODEL NO. EB330DSC		
		P3/5		
NO	DESCRIPTION	BOM	SPEC	QTY
85	Vise Handle	32061		1
86	Vise Handle Fixed Board	30086		1
86*1	CAPscrew	XCCMWS6820	CAP8*20	3
87	Spring	32033		1
89	Leadscrew	30089		1
90	Vise Handle Set	30090		1
91	Vise Handle Rod			1
91*1	Bearing	QX6904-2RS	6904	1
92	Leadscrew Copper	30092		1
92*1	Leadscrew Spring	30092*1		1
93	Moveable Vise Jaw Bracket	30093		1
93*1	Moveable DownVise Jaw Bracket Board	30093*1		2
93*2	Set screw			1
93*3	Screw			4
93*4	Set screw			1
94	Knob	30094	M10*190	1
95	Vise Plate	30095		1
95*1	Screw	XCM6F1020		2
96	vise cover	30096		1
96*1	Screw	XCM6F820	M8*20	6
96*2	Spring pin	XCWMWCG516	彈簧稍M5x16	2
96*3	Nut	XCM6A8	M8	6
97	Slide	32055		1
98	Left Vise	30098		1
98*1	Screw	XCM6F1040	10*40染黑	4
98*2	Screw	XCM6F1040	10*40染黑	2
98*3	Screw	XCM6F1040	10*40染黑	2
98*4	CAPscrew	XCCMWS6840	CAP 8*40	2
98*5	Washer	30098*5		4
99	Left Vise Plate	30099		1
100	Left Cutting Plate	30100		1
101	Fixed Vise Jaw Bracket	30101		1
101A	O ring	OV008	4.4*2.6	1
101*1	Screw	XCCMFS61025	CAP10.25	6
101*2	Indicator Fixed Board	30101*2		1
101*3	Screw			1
102	Moveable Vise Jaw Bracket Board	30102	16x75x430	1
102*1	Screw	XCMA825	皿頭8*25	3
102*2	Washer	XCCMWS6825	23*8*3	4
102*3	CAPscrew	XCCMWS6825	CAP 8x25	2
103	Bearing 51106	27086	51106	1
104	Nut	27113		1
104B	45degree Plate	27124G*4		1
104A	Screw	XCM6F1030		1
105*2	Nut	XCM6A10		3
105A	Base	30105A#7037		1
105B	Front door	30105B		1

PARTS LIST		MODEL NO .EB330DSC		
NO	DESCRIPTION	BOM NO	SPEC	QTY
105C	CAP Screw	XCCMWS6825		2
105D	Washer	XCMM8233	8x23x3	3
105E	Screw	XCM6F1040		2
105F	Screw			1
105G	Set Nut			1
105H	Nut	XCM6A8	M8	1
105I	Handle	21GT15A/21GT14		1
106	Zeo Degree Fixed Board	30106	Φ25	1
106A	Handle	12060B	M8x30	1
106B	CAP Screw	XCCMWS61040		1
106C	Washer	XCMM8233	8x23x3	1
106D	CAP Screw	XCCMWS816	CAP M8*16	1
106E	Nut			1
107	Tank	30107#7037		1
108	Right Cutting Plate	30108		1
108*1	Screw	XCMA820	8x20	6
109	Vise Copper	30109	20*19	1
109*1	Vise Iron	30109*1	20*19	1
110	Knob Nut	27108		1
111	Screw 6*20	XCM6F620		1
112	Stop Braket	27107		1
113	Rod stock stop	27106		1
114	Right Vise	30114		1
115	Knob	32059*1		1
116	Plate	30116		1
116*1	Screw	XCCMWS6825		1
117	Right Vise Plate	30117		1
118	Miter Plate	30118		1
118*1	Screw			2
118*2	Oil Head	SU005	10x1.0直	1
118*3	Nut			2
118*4	Nut	XCM6A8		1
118*5	screw			1
119	Breaking Eletronic Board	30119		1
119*1	CAP Screw	XCCMWS6820		1
120	Nut	27113		1
122	Anti-Chip Cover	27037		1
123	Bushing	27111		1
124	Bearing 32006	QX32006		2
125	cylinder support	30125		1
125A	Spring holder	12080		1
125B	Spring support	21118G		1
125*3	Washer	XCMM8233	墊片8*23*3	1
125*1	Screw	XCCMWS6825	CAP 8*25	1
125*2	Screw	XCCMWS1065	CAP 10x65	1
125*4	Pin	XCWMWCG630	彈簧削6*30	2
125*5	Nut			1



PARTS LIST				P5/5
MODEL NO. EB330DSC				
NO	DESCRIPTION	BOM NO	SPEC	QTY
125*6	Screw	XCCM1S61230		1
126	Cylinder	30126		1
127	Oil house support plate	30127		1
127*1	screw	XCM6F825		1
128	Electronic control support	30128#7037		1
128*1	screw			4
128*2	CAP Screw	XCCMFS61030		2
129	Swivel table	30129		1
129*1	Angle stick			1
130	Main shaft	30130		1
131	Bearing 32006	QX32006	32006	1
133	Switch cover	285200#7035		1
132	Switch Base	285200*1#7035		1
134	PUMP	1Q013		1
134A	screw			4
134B	L-copper	27136*1G		1
136	Tank	30136		1
137	House	30137		1
137A	Tube Bundle			1
138A	Front door support frame	30138A		1
138B	Back Support Plate	30138B		1
138C	Right Support Plate	30138C		1
138D	Left Support Plate	30138D		1
138E	Down Plate	30138E		1
T02	screw		M6*15	4
T02-1	Washer		M6	2
T03	screw		M10*25	4
T04	Washer		M10X27X3	4
T05	screw		5/16x1/2	8
T06	Nut		Nut 5/16	8
200	Switch Set			1
201	Speed Switch			1
202	Main switch			1
203	3 Position Button			1
204	Emergency switch			1
208	Fuse and Bridge (2A)			1
209	Fuse			1
210	Switch Cover			1
211	Screw			1
212	Terminal Block			1
218.220.222	Wire for cooling pump and motor			1
215	Plug			1
216	Fuse and Bridge (6A)			1
217	Contact (Saw Motor High Speed) / 24V			1
219	Feed EL Valve			1
223	Approach EL Valve			1
225	Start Switch			1
73	Cable Protector			1

